

User Manual

Our products have been designed and manufactured in such a way to ensure that all quality, functionality and aesthetic requirements are met. We would like to congratulate you on the purchase of this great product and wish you a pleasant experience with it.

Electric radiator

Guide to safe installation and use.

1. Do not install the heater under an electrical socket point.
2. Your electric heater should be filled with a carefully measured amount of liquid. In the case of loss of heating medium, or in any other case which demands its supplementation, contact your supplier.
3. If the device is not equipped with an external temperature sensor do not use the device in a small room if unsupervised disabled or incapacitated individuals are inside it. Only use the device if those individuals are under constant supervision.

4. Electric heater is not a toy. Children under the age of 3 should not be allowed within close proximity of the device without the supervision of an adult.

Children aged 3 to 8 should only be allowed to operate the heater when it has been properly installed and connected. The child must be under adult supervision or have been trained to safely operate the device while understanding the risks.

5. Note: Some parts of the radiator can be very hot and can cause burns. Pay special attention to the presence of children or people with disabilities.
6. If the device is used as a clothes and towel dryer, ensure that the fabrics drying on it have only been washed in water, avoiding contact with any harsh chemicals.

7. To ensure the safety of very small children, install the electric dryer so that the lowest tube is at least 600 mm above the floor.
8. The device should only be installed by a qualified installer in accordance with the applicable regulations regarding safety and all other regulations.
9. All installations to which the device is connected should comply with regulations applicable in the country of installation and use.
10. Extension leads or electric plug adapters should not be used in order to supply power to the heater.
11. The electric installation to which the heater is connected should have the right current differential and overcurrent relay (R.C.D.) of 30 mA. With the permanent installation (cable connection without plug) it is also mandatory to have an omni-pole cut-out for disconnecting the device on all poles, by points of contact with the clearance of 3 mm.

12. The device version labelled PB or MS can be installed in bathrooms in zone 1, as defined by applicable law, subject to any additional regulations concerning electrical installations in wet areas. Other versions of the device can be installed in Zone 2 or beyond.
13. The device is recommended for use solely as described in the manual.
14. Ensure that the heater has been installed on a wall in accordance with its installation manual.
15. Please forward this instruction manual to the end user.

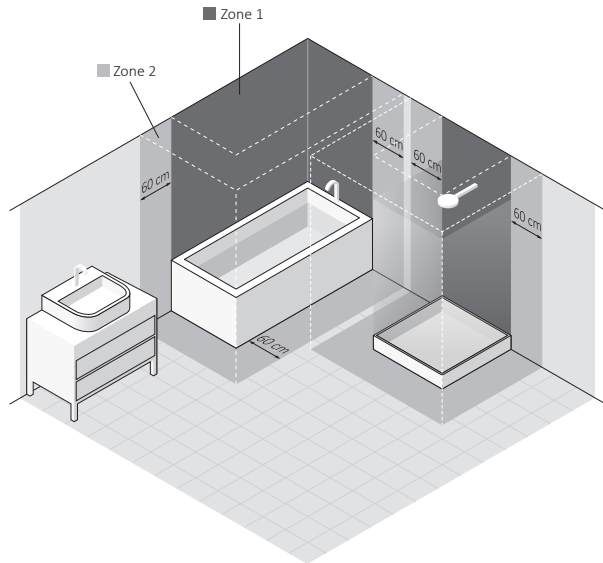
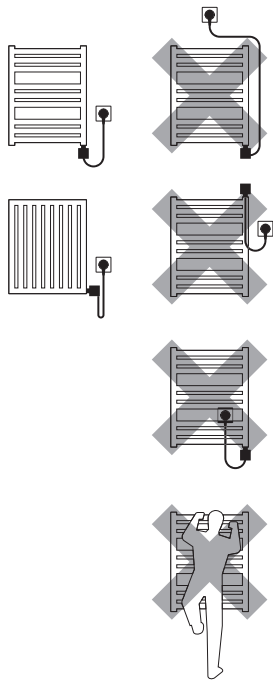

Electric Heating Element

Safety requirements – installation

1. Fitting and connection of the heating element should only be performed by a qualified installer.
2. Connect the unit to a sound electrical installation (see the ratings on the heater).
3. Switching on the heating element in the open air to test the device is permitted for a maximum of 3 seconds.
4. Never test a heating element that is already installed. Do not turn the heating element on in an empty radiator!
5. Ensure that the power cord does not touch the hot parts of the heating element or radiator.

6. Before installing or removing the device, make sure it is disconnected from the power source.
7. Do not open the device – any interference with internal components will invalidate the warranty.
8. The heating element's power output should not exceed the radiators power output for the parameters 75/65/20°C.
9. The pressure in the radiator must not exceed 1 MPa (10 bar). Ensure that an air cushion is preserved in electric radiators. In central heating systems, leave one valve open to prevent pressure build up due to the thermal expansion of the liquid.
10. The device is intended for home use only.
11. Fitting and Installation of the device must be carried out in accordance with all local regulations for electrical safety, including installa-

tion within permissible locations only. Observe bathroom electrical zone regulations.

Safety requirements — use

1. The heating element must be fully submerged in the heating liquid during its operation.
2. Regularly check the device for damage to ensure it is safe to use.
3. If the power cord is damaged the device should not be used. Unplug the device and contact the manufacturer or distributor.
4. Do not allow flooding into the heating element casing.
5. Do not use the heating element in heating systems where the water temperature exceeds 82°C.

6. The heating element and radiator can heat up to high temperatures. Please be cautious – avoid direct contact with the hot parts of the equipment.
7. Do not open the heating element casing.
8. When operating the heating element in a radiator connected to a central heating system, always leave one of the valves open.
9. Ensure that minors aged 8 and above or those with a physical or mental disability are supervised if operating the device.
10. The device is not a toy. Keep it out of the reach of children.
11. The device must be disconnected from the mains during cleaning and maintenance.
12. Cleaning of the equipment by children under 8 years of age is only permitted under appropriate supervision.

Intended use of device

The heating element is an electric device intended solely for installation in radiators (standalone or connected to the central heating system) to serve as space heaters, or clothes and towels dryer.

Heating element power output should be matched with radiator output for parameters of 75/65/20°C.

Technical information

Model markings (power cable type)	<ul style="list-style-type: none">- PW (Straight cable with plug)- PB (Straight cable without plug)*- SW (Spiral cable with plug)- MS (screw connection + on/off switch)* <p>* <i>Device intended to be connected permanently to the system</i></p>
Power supply	230 V / 50 Hz
Heat outputs available	120, 200, 300, 400, 600, 800, 1000 [W]
Insulation class	Class I
Towel rail connection thread	G 1/2"
Casing protection class [IP]	IPx4: only the MS version IPx5: except the MS version
Temperature measurement:	Temperature inside the radiator and room temperature – through a sensor located in the housing or through an external Bluetooth sensor.

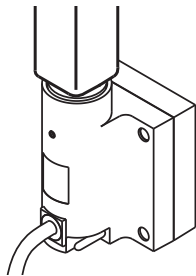

Power output of heating rod [W]	120	200	300	400	600	800	1000
Length of heating rod: [mm]	325	285	310	345	375	485	575

Installation or removal

Detailed information demonstrating the different ways of installing or removing a radiator heating element is available from the manufacturer or importer (see footnotes at the end of the manual). Below we list some basic requirements and principles which must be followed to ensure long term, reliable operation of the product.

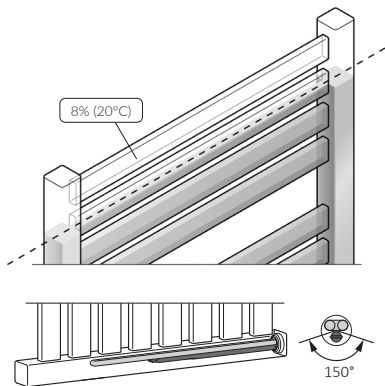

When the heating element is installed horizontally, it must be rotated to such an extent that the single tube, which houses the temperature sensor, is positioned as low as possible.

Before installation or first use:

1. Read the chapter *Safety requirements – Installation*.
2. Fit the heating element using the correct spanner (size  24).
3. The heating element must be installed at the bottom of the radiator, perpendicular to the radiator pipes, while preserving space for the proper circulation of the heating medium.
4. Use a suitable heating medium for filling the electric radiator, i.e. (water, special products based on water and glycol for use in central heating systems, or oil which complies with the requirements of the manufacturer of the radiator and heating element).
5. Check the distances between the individual heating element tubes and bend if necessary.

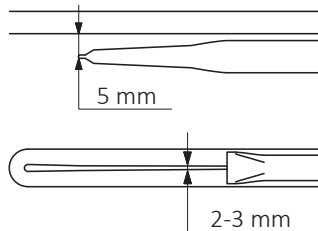

6. Do not switch the heating element on if it is not fully immersed in radiator heating medium (applies also to the first use)!
7. Make sure an adequate air cushion is present to protect against excessive pressure build up within the electric only radiator (or leave one of the radiator valves open in central heating system).
8. When filling the radiator with hot liquid insure that the liquid temperature does not exceed 60° C.
9. Follow the subsequent guidelines when connecting the electrical installation:
 - a. Brown wire – live connection to the circuit (L).
 - b. Blue wire – connect to neutral (N)
 - c. Yellow & green wire – earth connection (PE).
10. Before filling the radiator with heating medium, ensure that the heating element is fitted properly and that it is water tight.
11. In central heating installation radiator must be fitted with the valves enabling disconnection of the radiator from the rest of the system.
12. The temperature of the heating agent in the central heating system must not exceed 82°C!
13. For detailed installation hints – see the last pages of this manual.

Notes prior to removal:



1. Disconnect the device from electric circuit and ensure that the

radiator has cooled down before you start disassembling the radiator.

2. Release the screw at the back of the controller casing.
3. Take off the controller from the heating element.
- 4a. In case of dual-fuel radiator, close the valves and empty the radiator.
- 4b. Be careful – electric only radiator filled with heating liquid may be very heavy. Ensure all necessary safety measures.
5. For disassembling the heating rod use a spanner no 24.

Product disposal



This product should not be disposed of as general waste but should be brought to the appropriate collection point for recycling of electric and electronic devices. This information is provided by the sign on the product, user manual and packaging. Information on the appropriate point for used devices can be provided by your local authority, product distributor or the store from where the product was purchased. Thank you for your effort towards protecting the environment.

Maintenance

- Always disconnect the device from electricity before you start cleaning the radiator or heating element.

- Recurrently check level of the heating medium inside the radiator.
- Clean the item with a dry or damp cloth with a small amount of detergent without any solvents or abrasive agents.

Warranty terms & conditions

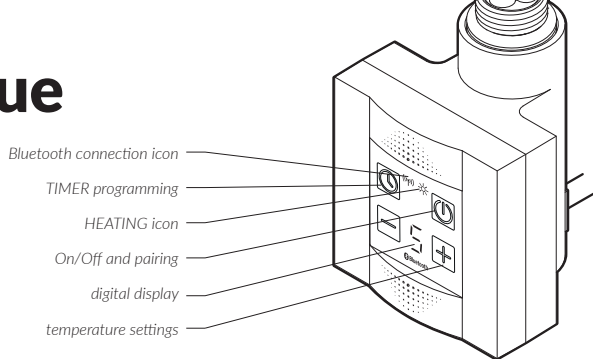

1. The subject of this warranty is a Terma electric heating element. The product name and characteristics are specified on the packaging.
2. By accepting the device on purchase, the Client confirms that the product is of full value. The Client should immediately inform the Seller of any discovered faults – otherwise it will be understood that the product was faultless at the time of purchase. This refers especially to any faults or damages of the control panel case.
3. The Warranty for period for the product is 24 months from the date of purchase, but no longer than 36 months from the date of production.
4. The proof of purchase (receipt, invoice, etc.) constitutes the basis for warranty claims. Lack of the proof of purchase allows the manufacturer to reject a warranty claim.
5. This warranty does not cover any faults that are due to:
 - incorrect (not in accordance with the manual) installation, use or disassembly,
 - incorrect use of the heating element (i.e. for any purpose that is not specified by the Manufacturer as intended for this type of product),
 - product being handled by unauthorized persons,
 - fault's or damages caused by the Client after having purchased and accepted the product.
6. The Central Heating installation should be fitted with lock-shield valves, enabling disassembly of the radiator or the heating element and its control head without the necessity of emptying the whole system of the heating agent. Any problems or expenses arising from the absence of lock-shield valves in your installation cannot be used as grounds for any claims against the Supplier or Manufacturer of the device.
7. The Manufacturer is obliged to remove any production fault within 14 working days of receipt of the faulty device at the Manufacturer's premises.
8. Should the repair be impossible, then the manufacturer is obliged to replace the faulty product with a new, full-value unit of identical parameters.
9. The attached User Manual is an integral element of the Warranty. Please read it carefully prior to the installation and use of the product.

KTX 4 Blue



The KTX 4 Blue electric heating element is equipped with a basic sensor for controlling the temperature of a radiator/towel rail and, depending on the version of the device, an additional sensor for controlling room temperature. **Note:** the factory settings of the heating element read the temperature of the radiator/towel rail. The built-in room temperature sensor* can be activated with the mobile application.

* Does not apply to MS version

All versions of the Blue heating element (also the MS version) can be connected to an additional external room temperature sensor.. Buttons  and  are used to regulate temperature whilst the  icon indicates that the radiator is being reheated.

Turning the device on does not mean that it uses the same maxi-

mum power for the whole time it is on. On turning the device on, it operates with the nominal power for a short period of time in order to heat up the radiator to the set temperature. After that it turns itself on and off periodically, using only as much energy as it is required to maintain the set temperature of the radiator for current external conditions (see: *Actual working time meter*).

The basic temperature sensor allows you to precisely control the operation of the device and protects the user from getting burnt by limiting the maximum operating temperature to 60°C. Additionally, a thermal fuse, built into the heating rod, protects your radiator from critical overheating (the fuse can get damaged in temperatures higher than 82°C – this is especially important for heating elements installed in dual fuel radiators, connected to central heating system).

Construction of the heating element unit as well as physical char-



acteristics of the heating agent cause that the bottom pipes (especially the two at the very bottom of the radiator) may have a lower temperature than the remaining parts of the radiator – this is a normal phenomenon.

KTX 4 Blue controller installed on the SPLIT heating element make up a set that can be operated directly (see *Manual operation section*) or via mobile device - smartphone, tablet (see *Remote operation section*).

MANUAL OPERATION (direct manual controller operation)

No need to have a mobile device with a controlling app installed.

Heating mode

It is possible to set 5 temperature levels in the local mode. Settings are modified with  and  buttons. Possible working levels are as follows: 0 (does not heat) and from 1 to 5, indicating a temperature range from 30 to 60 degrees Celsius. The * icon indicates that the device is heating.

Dryer mode (Timer)

 button is used to turn the mode on and set the time after which the device is to be turned off automatically. In order to activate the Dryer Mode:

- press  button shortly – display panel will show dryer working





time of 1H (1 hour),

- every subsequent pressing of the  button will prolong dryer working time (2-4 hours).

In order to deactivate the Dryer Mode, set the time to 0H (press the  button a few times) or turn the device off and back on.

Letter „H“ flashes throughout the whole time, the TIMER function is used.

During that time:

- to see the set temperature press once any of the  /  buttons,
- to change the temperature setting press the  or  button a few times,
- press the  button to modify the time after which the Dryer mode will be terminated.

Actual working time meter

The unique feature measuring the actual working time of the heating element adds up the periods during which the device was using nominal electric power (during standard operation the device regulates the temperature and uses very little power thanks to the fact that it turns itself off for longer periods).

It can be checked at any time how much electricity has been used, ie. during all day's operation. In practice it turns out to be up to a few dozens of percent less!

1. Meter reading:

Press and hold the  button – the display panel will show letter E followed by 4 digits separated by a hyphen (actual operating time of the device), ie. E..0..2..-..1..5 means that the device was actually working for 2 hours and 15 minutes from the last time the meter was zeroed.



2. Meter resetting:

Press and hold the  button until E 00-00 comes up.

The number displayed on the meter reflects the actual energy consumption, therefore you can measure the actual cost of energy used by multiplying the number on the meter by the nominal heating output of the heating element and the price of electricity (1 kW).

Remote operation (via a mobile device with an installed control app)

KTX 4 Blue controller has a built-in and constantly operating Bluetooth Low Energy communication module. It serves the purpose of remote operation of the heating element with the use of popular mobile devices, both smartphones and tablets, run on both Android (min. 4.4) and IOS (min. 6.0). The heating element is seen by other Bluetooth devices as a Heating Element KTX Blue. If it is necessary to pair devices, it may also be necessary to provide an authorisation code: 123456.

In order to start the pairing process, press and hold the {on/off} button for 5 seconds. The  icon will begin to flash. Pairing process takes about 30 seconds. The  icon flashes also, whenever an active connection (information exchange) is established with an external control device.

TIMER mode

The control mobile application allows to set timer mode for anything between 1 – 240 minutes, in all available temperature ranges as well as to choose the mode of temperature measurement either radiator temperature or room temperature.

Automatic heating programme cycles

The control mobile application allows to programme several different 7-day heating cycles and save them on any paired heating element. Successful saving of heating programme cycles is followed by a message on your mobile device and a horizontal line on the display of the device. From this moment, the heating element works according to the saved heating programme cycle

Anti-freeze mode

In case the device is off (switched off with button ) but remains connected to the mains and the ambient temperature falls below 6°C, the device will switch itself on to prevent heating agent in a radiator from freezing. An 'F' letter will blink on the display unit until the anti-freeze mode finishes, which is when the temperature rises above 6°C.

Problem solving

Problem	Possible cause	Solution
Device is connected to electricity, LED display panel is empty	Connection problem	Check the power wire connection, plug and the socket
Heating element does not heat, LED display panel shows E2 code	Device signals malfunction, overheating possible.	Check and confirm that the heating element's output does not exceed the recommended output of your radiator. Check and reduce the water temperature in the central heating system-must not exceed 82°. In electric-only version check, if the radiator is properly filled with the heating agent.
Heating element does not heat, LED display panel shows E1 code	Controller is incorrectly installed on the heating element	Check if the head of the heating element is completely hidden. Release the screw at the back of the controller casing, gently push the controller towards the radiator and secure the casing back
During operation, the icon (🔊) turns itself on.	It indicates data transfer to/from the control unit.	The heating element is working properly.
Heating element is heating despite being turned off with the (🔇) button	Electronics damage	Disconnect the device from its electric supply, wait for the radiator to cool down and turn it back on.
If the problem persists, please contact your local distributor		