

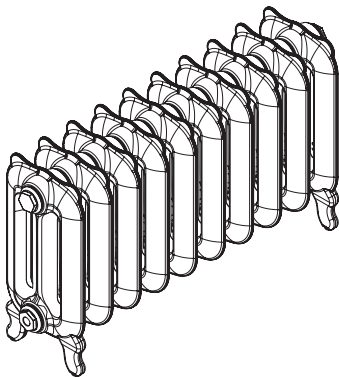

TERMA

SINCE 1990



User Manual

Cast-iron radiator

Instrukcja użytkowania — Grzejnik odlewany | Betriebsanleitung — Gegossener Heizkörper (Gusseisen) | Mode d'emploi — Radiateur fonte | Инструкция по применению — чугунный радиатор | Manuale d'uso — Radiatore in ghisa

EN

PL

DE

FR

RU

IT



WARRANTY CONDITIONS

1. This warranty applies to the cast-iron radiator manufactured by TERMA Sp. z o.o., hereinafter referred to as the 'Manufacturer' with parameters specified on the last page of this booklet.
2. By accepting the product the Consumer confirms that the product is of full value, free from any defects, in particular paint coating faults. In case of any defects the Consumer should inform the Seller, hereinafter referred to as the 'Trading Partner'.
3. The warranty periods are:
 - 8 years for water tightness,
 - 8 years for radiator paint coating,
 - 4 years for Galvanic Copper finish
 - 2 years warranty for finishes: Metal Alive, Burnish, Enhanced Ornament – Silver, Raw, Polished.
4. The product warranty card and evidence of purchase are prerequisites for any claims resulting from the warranty. The Trading Partner or Manufacturer may reject the claim if any of the above has not been supplied.
5. The warranty does not cover:
 - product faults resulting from incorrect (not in compliance with the manual) installation or use;
 - product faults resulting from using the radiator in defiance of the requirements specified in the attached manual – in particular those regarding the pressure inside the radiator;
 - damage caused by the Consumer after receiving the product from the Trading Partner.
6. The warranty does not apply to any claims related to technical and functional features of the radiator, as long as they conform with those stated in the manual and technical specifications.

7. The warranty applies only to the first installation of the radiator.
8. The radiator may be disassembled (have its sections taken apart) only by the Manufacturer or an authorised installation professional.
9. The warranty service does not include any activities described in the user manual, and customarily performed and paid for by the Consumer.
10. It is recommended to install valves on the supply and return pipes making it possible to disconnect the radiator from the central heating installation. If valves are not fitted the Consumer covers the extra cost of radiator dismantling.
11. Every claim is processed within 14 days of its receipt back to the Manufacturer.
12. If the claim is accepted, the Manufacturer will repair the faulty product. The time required for the repair will be agreed with each Consumer individually. If the product cannot be repaired the Manufacturer will replace it with a new one.
13. User manual is an integral part of the warranty documentation. Please read it carefully before using the product.

PRODUCT INFORMATION

1. MATERIALS: cast iron, two coats of paint (one paint layer and one special protective lacquer finish).
2. TECHNICAL PARAMETERS: detailed product data can be found on the last page of this booklet.
3. INTENDED USE: interior heating only.
4. PLACE OF USAGE: rooms with a normal air humidity environment without any corrosive factors (this also applies to bathrooms, kitchens etc.).
5. INSTALLATION: the wall-mounted version requires special fixing brackets; for the standing version with height ≥ 550 mm we recommend a retaining wall stay. Connection to central heating installation is with G $\frac{1}{2}$ " threads.

6. MAXIMUM TEMPERATURE: 95°C
7. WATER PRESSURE: working at up to 10 bar (1,0 MPa); tested at 15 bar (1,5 MPa).
8. Our radiators fully comply with:
 - Polish Standard PN-EN 442-1:1999 – Radiators with related standards and amendments (in particular – PN-EN 442-1:1999/A1:2005),
 - Declaration of compliance with the European Parliament Directive, Regulation (EU) No 305/2011 dated 9 March 2011 regulating the conditions for the marketing of construction products and replacing Council Directive 89/106/EEC.
9. The radiator can be equipped with an electric heating element.
10. MANUFACTURER: TERMA Sp. z o.o., Czaple 100, 80-298 Gdańsk, Poland.

GENERAL INSTALLATION NOTES

1. Special caution must be taken while transporting, installing or dismantling the radiator in order to avoid any harm or damages. Please follow carefully the illustrated guidelines included in this manual showing the correct way to carry the radiator – see: INSTALLATION.
2. Due to heavy weight, the product is transported on a pallet and must not be taken off it until it is delivered to the Consumer.
3. The place designated for the installation of the radiator should be equipped with central heating installation pipe endings matching the radiator connection spacing specified in the technical specifications section. Additional information can be obtained from our Trading Partners and found on our website: www.termaheat.pl.
4. We recommend the use of valves on the supply and the return of the radiator.
5. When converting the radiator into an electric unit (filled with the heating medium and not connected to central heating installation) you must consider and bear in mind the thermal expansion of the heating medium – pouring too much liquid into the radiator may result in critical pressure levels and, ultimately, cause damage to the radiator.

CAUTION! We strongly recommend having the radiators installed by a qualified professional.

INSTALLATION

1. Safe installation requires at least two people.
2. Dispose of packaging immediately after unpacking the radiator – packaging can be dangerous to children.
3. In order to lift up the radiator from the pallet and move it around, use straps looped between the radiator sections.

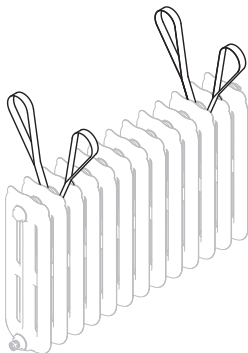

4. Special caution must be taken while lifting up the radiator from the pallet.

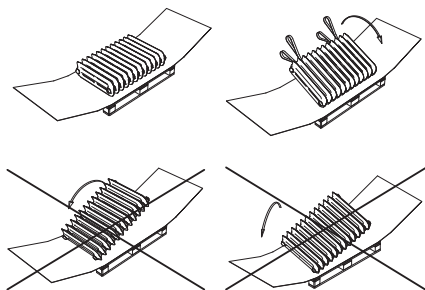

CAUTION! Radiators consisting of more than 14 pieces are shipped in shorter sections. The assembly instruction can be found in the RADIATOR ASSEMBLY section.

5. Before installation prepare the valves. Each valve should be divided into two parts. The threaded connector with a nut should be fitted to the radiator with a hex key, whereas the valve casing should be fitted to the central heating pipe.
6. While fitting the radiator remember about sealing the threads with suitable materials.

CAUTION! Too much insulating material on the thread can reduce water tightness of the valve or damage it.

7. Remove the temporary plastic plugs. Replace them with:
- air vent (in the uppermost opening of the radiator),
 - threaded connectors with valve threads (fittings).

8. Connect valve casings to the installation.
9. Once the connections are fitted, place the radiator next to the central heating pipes in order to make sure that the nuts on the threaded connectors match the valves attached to the installation piping.
10. Please contact our Trading Partners or consult our online catalogue in order to obtain information about fixing brackets spacing required for a particular size of radiator:
www.termaheat.pl.
11. In the places indicated below make holes for the suitable wall plugs.

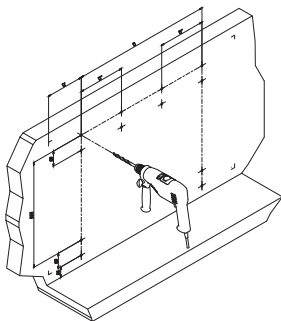

CAUTION! Check the wall condition and make sure the selected wall plugs can support the full weight of the radiator filled with the heating medium. Technical specifications of the radiator can be found on the last page of this manual and on the website: www.termaheat.pl.

12. Attach the fixing brackets to the wall.

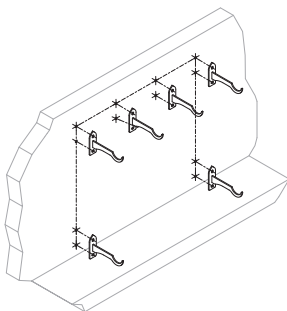

13. While hanging the radiator use the included straps. If this is a free-standing model, use the straps while moving it to the installation location.



CAUTION! Mount the radiator using the included fixing brackets only. Using other wall fixings is not recommended for safety reasons.

RADIATOR ASSEMBLY

1. To make assembling easier place the radiator sections flat onto a firm, clean, and flat surface.
2. Remove the plastic plugs protecting the threads before joining the sections.
3. If necessary clean the threads and connection areas.
4. Insert the joining collars into the threaded connections and secure them with a quarter turn.

CAUTION! Threaded connections and the joining collars have a right-hand thread at one end and a left-hand thread at the other. Each section has a right-hand thread on the side with the Manufacturer's logo. Each joining collar has a right-hand thread on the side with an inside bevel, marked with a red dot. The right-hand thread in the section should be matched with the right-hand thread of the joining collar.

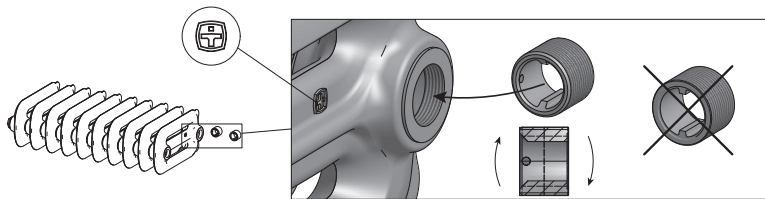

5. Put the sealing washers onto the connecting collars.

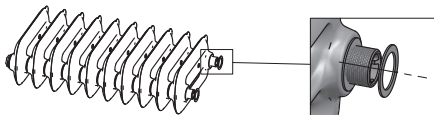

6. Put the sections to be joined close together, making sure both lie on the same side. The manufacturer's logo on each section should be facing the same way.

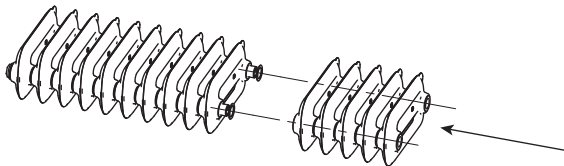

7. Manually turn in both joining collars at the same time. Make sure that both joining collars catch the threads on both sides.

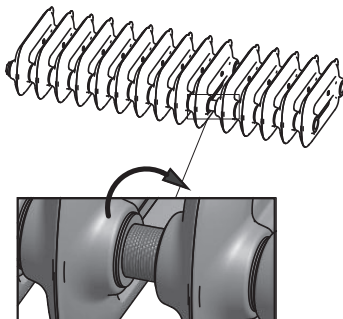

8. Determine how deep the collar turning key needs to go and mark this distance on the key shaft with e.g. a thick marker (see image below).

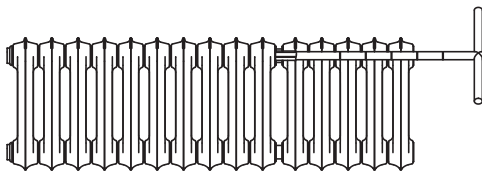

9. Insert the key into the open end of the waterway to the point marked on the shaft. Make one complete turn of the key on the top collar and then the bottom collar making sure that the joined sections remain parallel, then repeat this process for each section or group of sections to be joined.

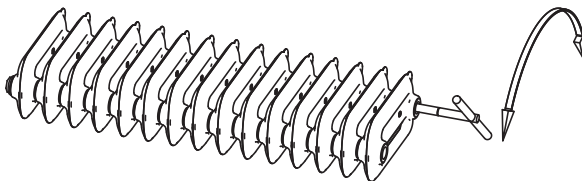

10. After joining the sections fit the plugs with sealing washers into the open waterways.

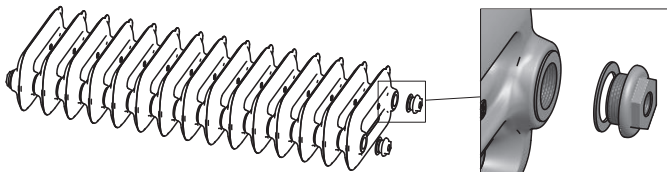

SAFETY PRECAUTIONS

1. Be careful while putting hands between radiator sections.
2. If the radiator is equipped with an electric heating element, please follow the basic safety rules below:
 - do not spill any liquid on the radiator,
 - do not touch the radiator while standing with bare feet on the ground or touching any grounded objects (e.g. bath, sink, etc.), especially in higher humidity conditions,
 - persons with electric pacemakers should take caution while standing next to the device.
3. Do not put loads exceeding 5 kg on the radiator.
4. Any changes in the construction of the radiator and/or warranty repairs may only be conducted by the Manufacturer or an authorized installation professional.
5. Observe the operating parameters specified in the PRODUCT INFORMATION section. This applies in particular to the working pressure, because excessive pressure can destroy the radiator and bring about other damages.

FAILURE SITUATIONS

In case of any signs of a radiator fault, such as a leak of the heating medium or any other abnormal symptoms, immediately turn off the valves and contact the Trading Partner or Manufacturer.

MAINTENANCE

1. Do not allow the temperature of the heating medium to fall below 0°C.
2. We recommend keeping the radiator clean. The radiator can be cleaned with domestic cleaning products except for those containing solvents or abrasives.
3. The Manufacturer cannot be held responsible for the effects of applying an additional layer of paint or lacquer to the radiator by the user.

RADIATOR DISMANTLING

Dismantling of the radiator should be performed by a qualified installation professional.

1. Turn off the valves on the supply and return pipes.
2. Relieve the pressure in the radiator by opening the air valve until the water stops pouring out.
3. Disconnect the radiator from the central heating installation, simultaneously removing water from the radiator.
4. Remove the radiator from the fixing brackets.

DISPOSAL

When permanently dismantling and removing the radiator observe your local law concerning disposal.