

Zehnder Valve Set 1

always the
best climate **zehnder**

Tools & Material Required

Allen key - 12mm
Adjustable Spanner

Key	Component	Qty
A	Manual Body (flow)	1
B	Manual Body (return)	1
C	Nut	2
D	Valve Tail (1/2" BSP)	2
E	Compression Fitting (15mm)	2

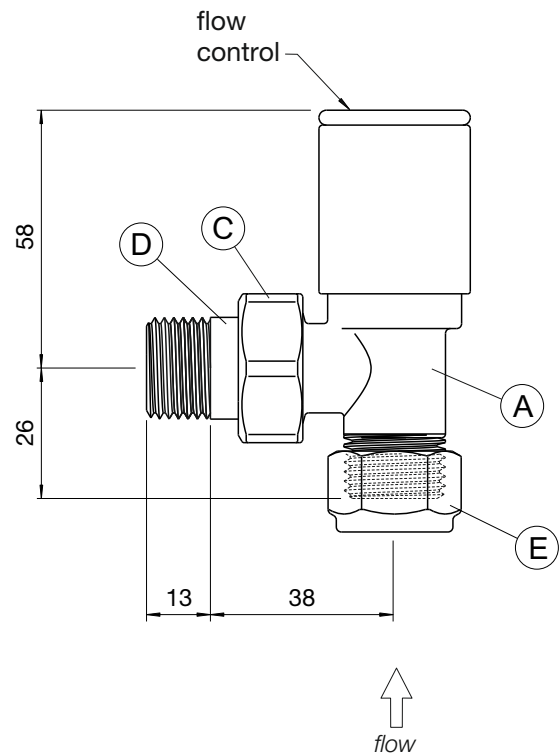
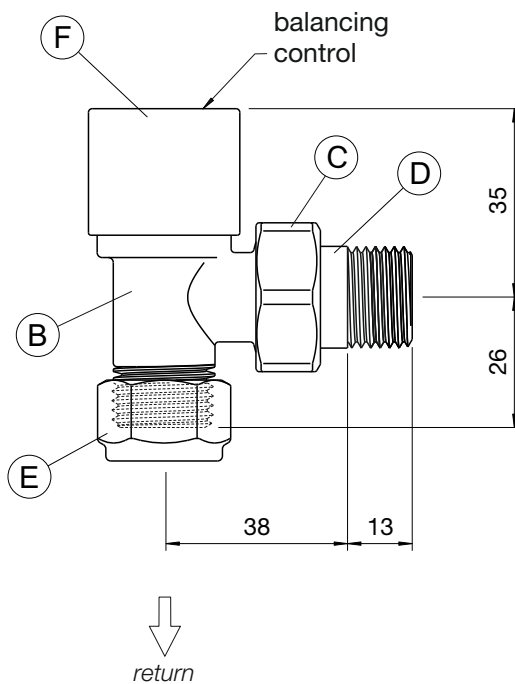

Fitting Instructions

Fit valve tails (D) to radiator using 12mm Allen key, ensuring nut (C) is in place.

Note: over-tightening of valve tails may cause damage to surface finish of radiator connections. Do not use grips.

Loosen compression fittings (E) and apply valve bodies (A) & (B) to 15mm pipe tails.

Install radiator onto bracket mountings and tighten valve tails (D) onto valve bodies (A) & (B).

Tighten compression fittings (E).

After filling and venting radiator, remove cap (F) and adjust balancing control to balance radiator.

Issue 1.0



Zehnder Group UK Ltd

Concept House
Watchmoor Point
Camberley
Surrey GU15 3AD

Tel: 01276 605800
Fax: 01276 24058
retailsales@zehnder.co.uk
www.zehnder.co.uk

Registered in England: 2296696